

AUSTRALIAN SHEPHERD

Installation Instructions

The Australian Shepherd Series antennas are high-performance, 5G, 600–6,000 MHz antennas, available with 4X4 MIMO LTE, 4X4 MIMO Wi-Fi and GPS. Australian Shepherd antennas are perfect for mobile and fixed wireless applications.



Mounting Preparation

Selecting Mounting Location

- For best performance it is important that the antenna be mounted on a conductive panel.
- Select the mounting location such that it is at least 18 inches or as far as possible from the other roof mounted items like antennas, light bars etc. to avoid any de-tuning or interference issues.
- Make sure there is enough clearance under the panel and there is no cross braces or double skin panel under the mounting location.
- Measure to check for central position if applicable.
- Remove the headliner under the marked location to avoid damaging it.

Importance of Mounting on a Flat Surface

A clean, flat, and level surface is recommended to install the antenna to properly seal the gap between the antenna and mounting surface. If the antenna must be mounted on a curved or a ridged surface use the appropriate Parsec gaskets for mounting the antenna. (sold separately).

Selecting the Mounting Option

- Roof Mount (Included)

Belgian Shepherd PRO series antennas can be mounted on an automobile roof or any flat surface using the hardware provided with it. (Figure 1)

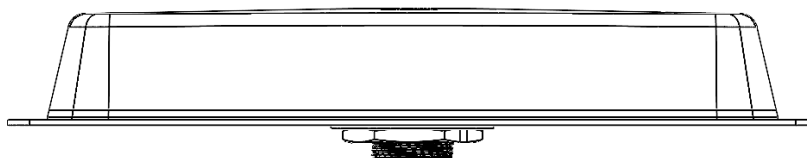

FIGURE 1

Preparing the Hole

Step 1.

After selecting the location to mount the Antenna, mask the mounting location to avoid paint damage. Then mark the hole center with ink or scribed cross hairs.

Step 2.

Use a center punch to make a dimple on the marked location to avoid drill bits from walking across the sheet metal. Then use a Twist drill of diameter about 0.1" and drill a pilot hole. Then using a 1.5" diameter sheet metal hole saw, drill the hole.

Step 3.

The hole saw will cut the required diameter hole with less risk of stretching and distorting the vehicle surface. Clean up any metal shavings from the hole cutting process. (Figure 3)

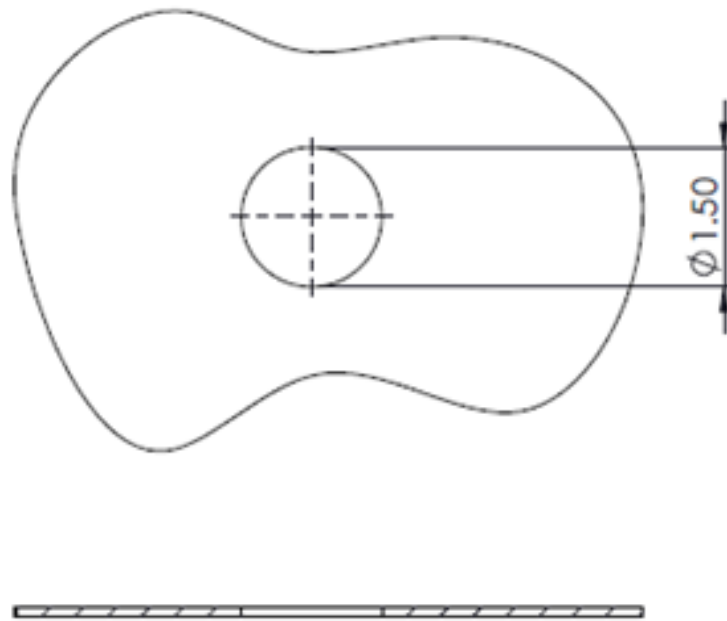

FIGURE 2

Step 4.

Clean up any metal shavings from the hole cutting process.

Mounting the Antenna

Step 1.

Feed the coaxial cables from the antenna through the hole from the outside surface to the inside surface and thread the entire length of the cable through the hole.

Step 2.

Clean debris off the vehicle surface and then mark the desired antenna orientation by placing the antenna flat on the vehicle surface.

Step 3.

Lift the antenna and remove the protective backing from the underside of the antenna and place the antenna back in the desired position. Apply downward pressure on the antenna to stick it to the panel.

Step 4.

To avoid the gap between the antenna and panel, it is recommended to use neutral cure silicon sealant around the base of the mounting boot to fully compress the antenna to the mounting panel.

Step 5.

A split flat washer and a split hex nut are provided in the kit for easy installation. (Star washer is optional and not supplied.)

On the inside of the vehicle, thread the flat washer over the cable, followed by star washer (if applicable) and then hex nut. (Figure 4 & 5)

Slide the washers and nut to the threaded flange of the antenna and tighten the hex nut until antenna compresses flat with the surface of the vehicle. (Figure 6)

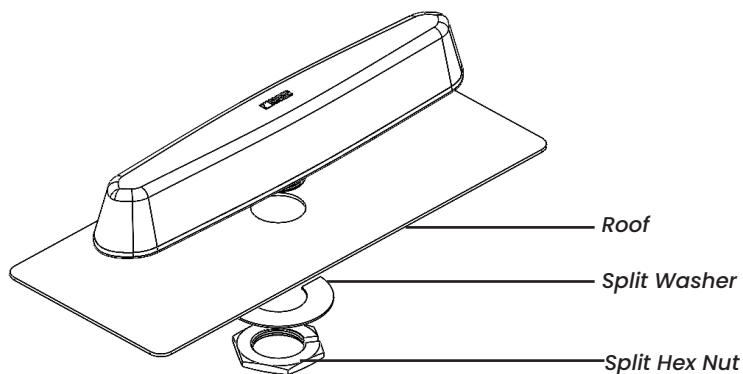

FIGURE 3

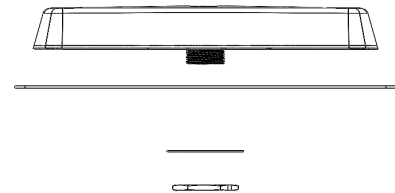

FIGURE 4

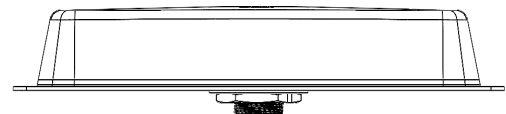

FIGURE 5

***** For best performance avoid bending the cable under 1" radius. And make sure the antenna is mounted in correct direction and tighten the mounting hardware. And waterproof the RF connectors using electric tape or a heat shrink tube if required.**

Cable Connection Instructions

Note: SMA connectors have a **maximum** torque of 3-5 inch lbs.

Step 1.

Clean the connector such that there is no dust in the terminals.

Step 2.

Connect the cables from the antenna to the designated connector on the antenna as shown in the table below.

S. No	Cable from Antenna	Connector on Router
1.	LTE 1	MAIN0
2.	LTE 2	MAIN 1 / MIMO 1
3.	LTE 3	AUX 1 / MIMO 2
4.	LTE 4	AUX 0 / DIV 0
5.	GPS	GPS
6.	WIFI - 1	2.4/5GHz
7.	WIFI - 2	2.4/5GHz
8.	WIFI - 3	2.4/5GHz
9.	WIFI - 4	2.4/5GHz
10.	Bluetooth (optional)	BT

For best MIMO performance use the following in pairs:



LTE 1 & LTE 4

LTE 2 & LTE 3

WIFI 1 & WIFI 2

WIFI 3 & WIFI 4

Not all antennas or routers have these cable leads/connectors. Only apply as needed.

	CAUTION To comply with FCC RF Exposure requirements in section 1.1310 of the FCC Rules, antennas used with this device must be installed to provide a separation distance of at least 20 cm from all persons to satisfy RF exposure compliance.
	DO NOT <ul style="list-style-type: none">• Operate the transmitter when someone is within 24 inches of the antenna.• Install antenna or mast assembly on a windy day• Install the mast close to power lines as it can cause serious injuries or death.
	WARNING This document gives the detailed instructions to install an antenna to the best of our knowledge. This document is for general information only. It cannot be used as a warranty. Parsec Technologies, Inc. will not accept any liability for any damage caused by an antenna due to unknown variables.